

Data Sheet



Article number: 071121400430060

Description: Cardan drive shaft 0.112.140.002
S=430 X=60 Bore with keyway

Measures

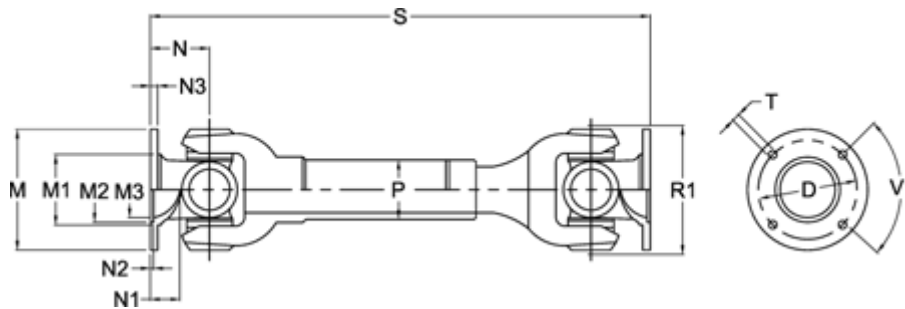

D	= 101,5 +-0,1	N1	= 26	T	= 8 B12
Extension X	= 60	N2	= 2,5 +0,5	V1 degrees	= 45
Flange diameter M	= 120	N3	= 8		
M1	= 80.5	Number of Flangeholes	= 8		
M2	= 75	P	= 60x4		
M3	= 69	R1	= 115		
Max. Bending Angle degrees	= 20	S min	= 430		
N	= 60	Spline dim. DIN 5480	= 42x2x20		